



Postmatic Equipment Manual

Model: 6000SA – Stamp Affixer

Part Number: 110000

Version: 7.1

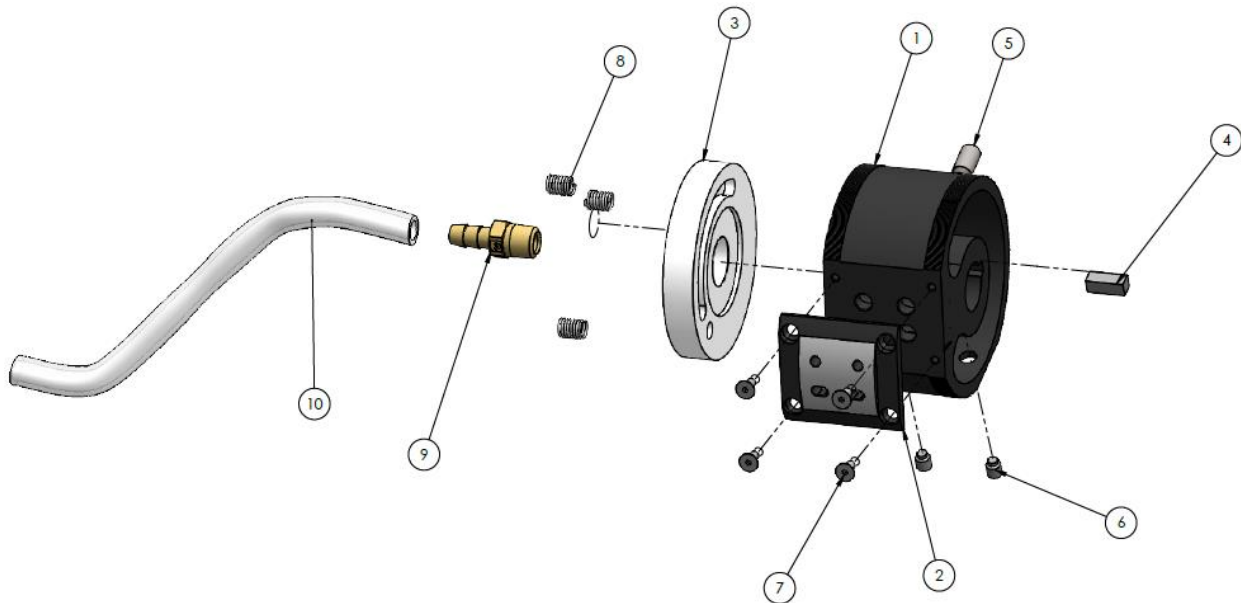

Table of Contents

PN 111001 – Assembly Vacuum Head	3
PN 111006 – Assembly Take Up Arm.....	4
PN 111008 – Assembly Stamp Roll Pivot	5
PN 111010 – Assembly Peel Bar Plate	6
PN 111012 – Assembly Nip Roller.....	7
PN 111014 – Assembly Main Shaft	8
PN 111022 – Assembly Knife Pivot	9
PN 111036 – Assembly Electrical Panel	10
PN 111052 – Assembly Frame & Cover	11
PN 111053 – Assembly Head End Plate	12
PN 111055 – Assembly Back End Panel	13
PN 111058 – Assembly Traction Feed Roller	14
PN 111070 – Sub-Assembly Circuit Board Pwr Supply	15
PN 111071 – Assembly Circuit Board Pwr Supply.....	16
PN 111078 – Assembly Interlock Cover	17
Technical Support	18

PN 111001 – Assembly Vacuum Head

Item No.	Part No.	Description	Qty.
1	100001	VACUUM HEAD	1
2	600026	STAMP PAD	1
3	100019	VACUUM VALVE	1
4	5010	3/16 X 1/2 SQ KEY	1
5	1230	1/4-20 X 1/2 SOC SET KC	1
6	2010	10-24 X 1/4 SOC SET G	2
7	1035	4-40 X 3/8 FHCS BLK	4
8	600063	VACUUM VALVE SPRING	3
9	8066	BARB FITTING 1/4" ID HOSE	1
10	8810	1/4 x 3/8 POLY TUBING	1



PN 111006 – Assembly Take Up Arm

Item No.	Part No.	Description	Qty.	Item No.	Part No.	Description	Qty.
1	200006	T/U ROLLER ARM	1	14	1180	10-24 X 3/4 FHCS BLK	2
2	200007	T/U ROLLER ARM SHORT	1	15	1120	8-32 X 1/2 FHCS BLK	6
3	100062	T/U ARM SHAFT	1	16	2010	10-24 X 1/4 SOC SET G	1
4	100061	T/U DANCER ARM	1	17	1040	5-40 X 1/4 SHCS BLK	1
5	100016	T/U ROLLER SHAFT	1	18	8180	BUSHING	1
6	633046	TENSIONER ADJUST WHEEL	1	19	8185	BUSHING	1
7	100545	DANCER ARM SPRING	1	20	8005	STAND OFF	3
8	100531	T/U ROLLER FRIC CLUTCH	1	21	8075	BUSHING	2
9	200019	TAKE UP ROLLER	1	22	8071	THRUST BEARING	1
10	100063	DANCER ARM ROLLER	1	23	5030	1/8 X 5/8 SPR PIN BLK	1
11	200038	T/U ROLLER ARM COVER	1	24	5028	1/8 X 1/2 SPR PIN Z	1
12	1072	5-40 x 1/4 BHCS	8	25	1224	10-24 X 1/4 SOC SET CUP PT BLK	2
13	1236	1/4-20 X 3/4 FHCS BLK	1				

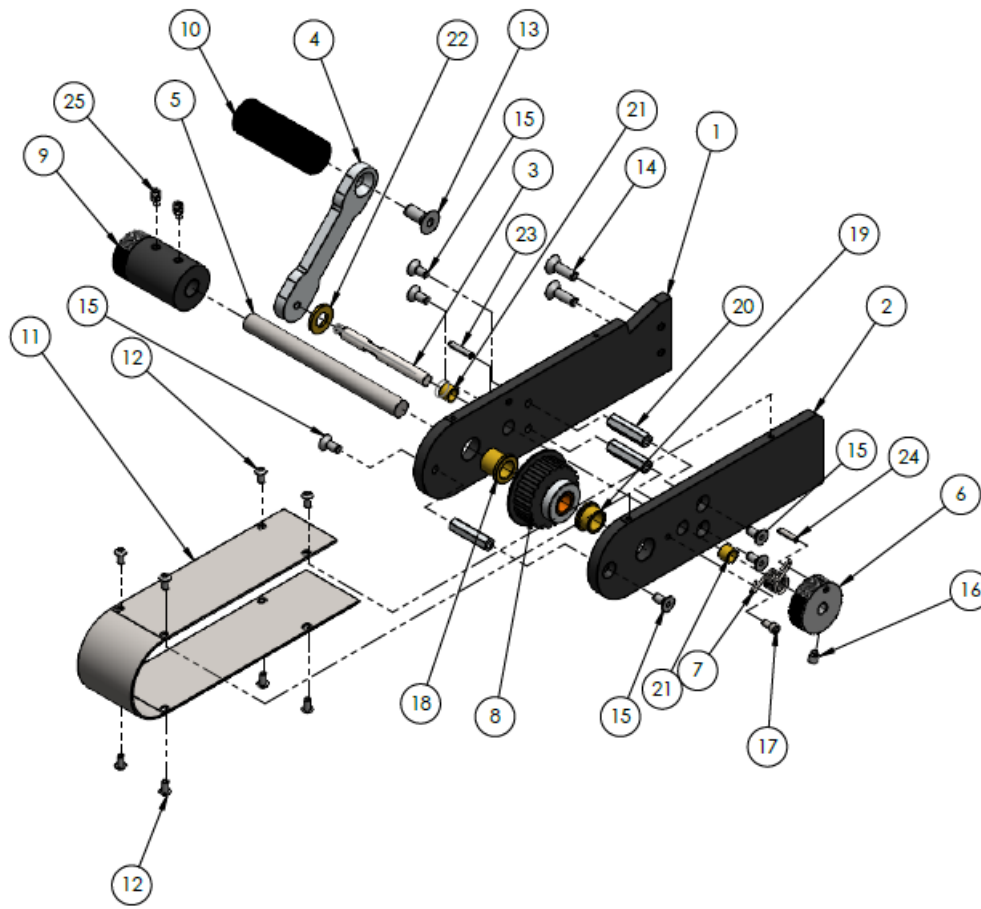

PN 111008 – Assembly Stamp Roll Pivot

Item No.	Part No.	Description	Qty.	Item No.	Part No.	Description	Qty.
1	200008	STAMP ROLL SUPPORT BAR	1	14	5028	1/8 X 1/2 SPR PIN Z	1
2	100017	STAMP ROLL PIVOT SHAFT	1	15	5030	1/8 X 5/8 SPR PIN BLK	1
3	8020	3/8 SET COLLAR	1	16	1040	5-40 X 1/4 SHCS BLK	1
4	200029	INNER AND OUTER SHEEVE	2	17	1200	10-24 X 3/4 SHCS BLK	1
5	200028	STAMP ROLL PIVOT	1	18	1190	10-24 X 1/2 SHCS BLK	2
6	733050	COVER HUB	1	19	1236	1/4-20 X 3/4 FHCS BLK	1
7	733056	SPRING PLUNGER	1	20	1070	5-40 X 1/2 FHCS BLK	3
8	200009	DANCER ARM	1	21	1065	5-40 X 3/8 FHCS BLK	3
9	633048	T/U ARM SHAFT	1	22	8075	BUSHING	1
10	100545	DANCER ARM ROLLER	1	23	8074	THRUST BEARING	1
11	633046	TENSIONER ADJUST WHEEL	1	24	8120	BUSHING	2
12	100545	DANCER ARM SPRING	1	25	5065	3/8" SNAP RING	1
13	2010	10-24 X 1/4 SOC SET G	1				

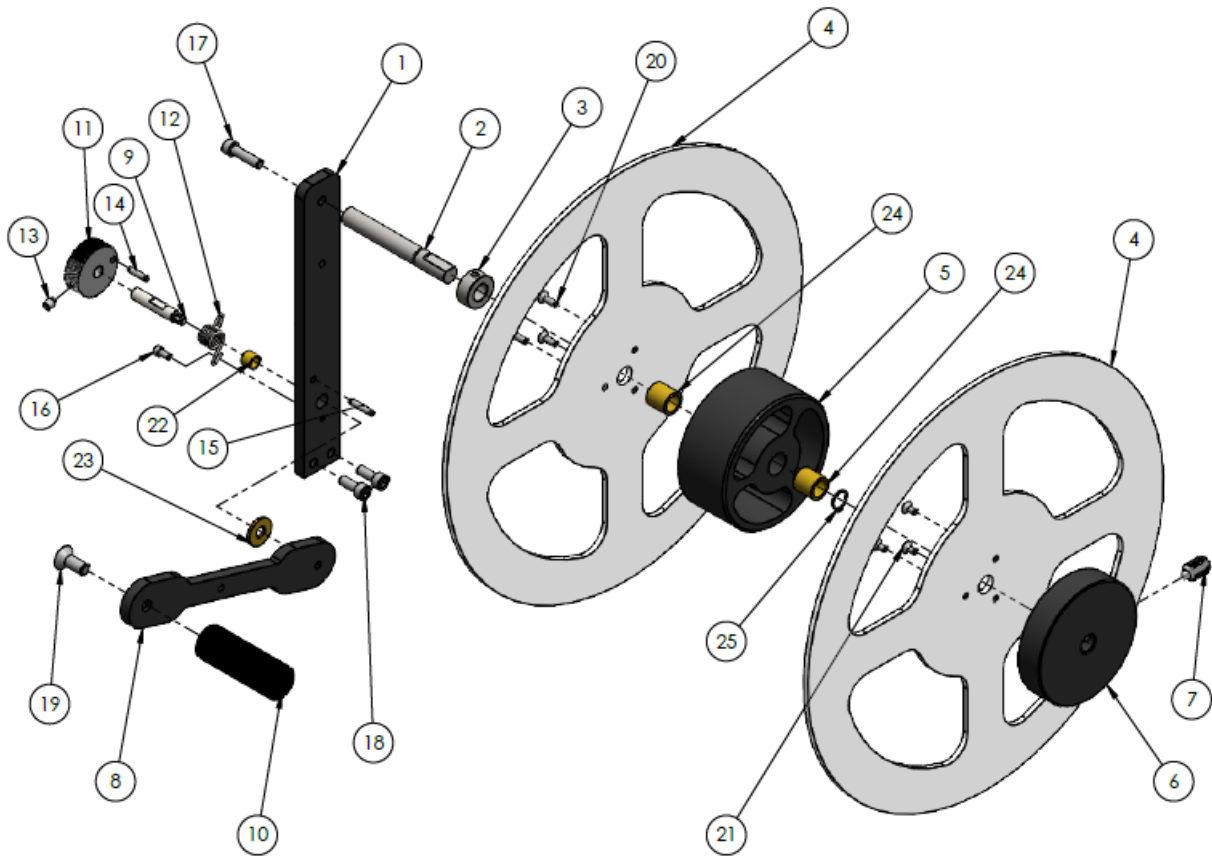

PN 111010 – Assembly Peel Bar Plate

Item No.	Part No.	Description	Qty.
1	100011	OUTER PEEL BAR PLATE	1
2	200011	STAMP PLATE MTG TAB	1
3	100009	PEEL BAR INSERT	1
4	100023 LH	FIBER CABLE MTG BLOCK	1
5	100023 RH	FIBER CABLE MTG BLOCK	1
6	100542	STAMP TENSIONER SPRING	1
7	100555	RETRACT SPRING PLUNGER-STUBBY	1
8	100505	OVAL APERATURE FIBER CABLE PR	2
9	100557	HEX NUT 1/4-20	1
10	4065	#6L FL BRASS WASHER	2
11	1095	6-32 X 5/8 SHCS BLK	2
12	1050	5-40 X 3/8 SHCS BLK	3
13	1085	6-32 X 3/16 BHCS BLK	6
14	100010	STAMP PEEL BAR PLATE	1

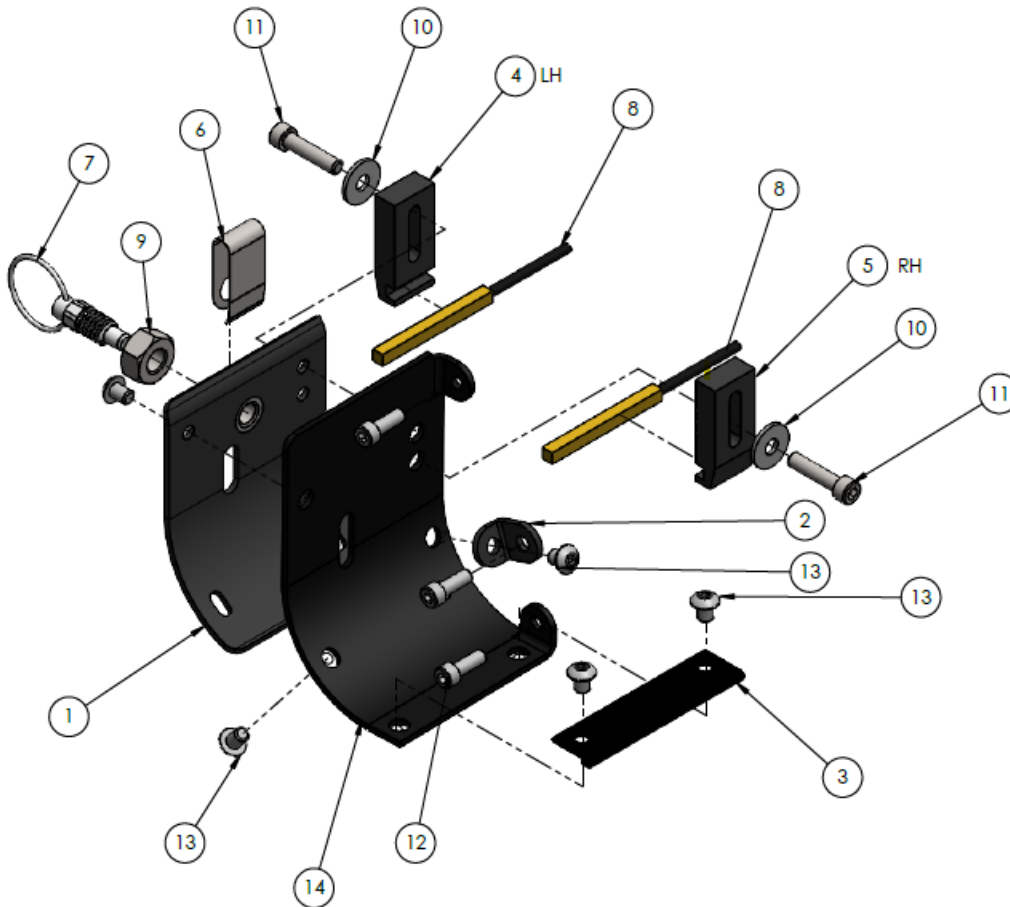

PN 111012 – Assembly Nip Roller

Item No.	Part No.	Description	Qty.
1	200013	OUTER NIP ROLLER ARM	1
2	3030	5/16 X 1-1/4 SH BOLT	1
3	3035	5/16 X 2 SH BOLT	1
4	200012	INNER NIP ROLLER ARM	1
5	8125	BUSHING	2
6	4040	1/4-20 JAM NUT Z	1
7	8010	5/16 ID SET COLLAR	2
8	100550	NIP ROLLER	1
9	100540	NIP ROLLER SPRING	1
10	1183	10-32 X 1/2 SHCS BLK	1
11	1169	10-32 X 3/16 SOC. SET	1

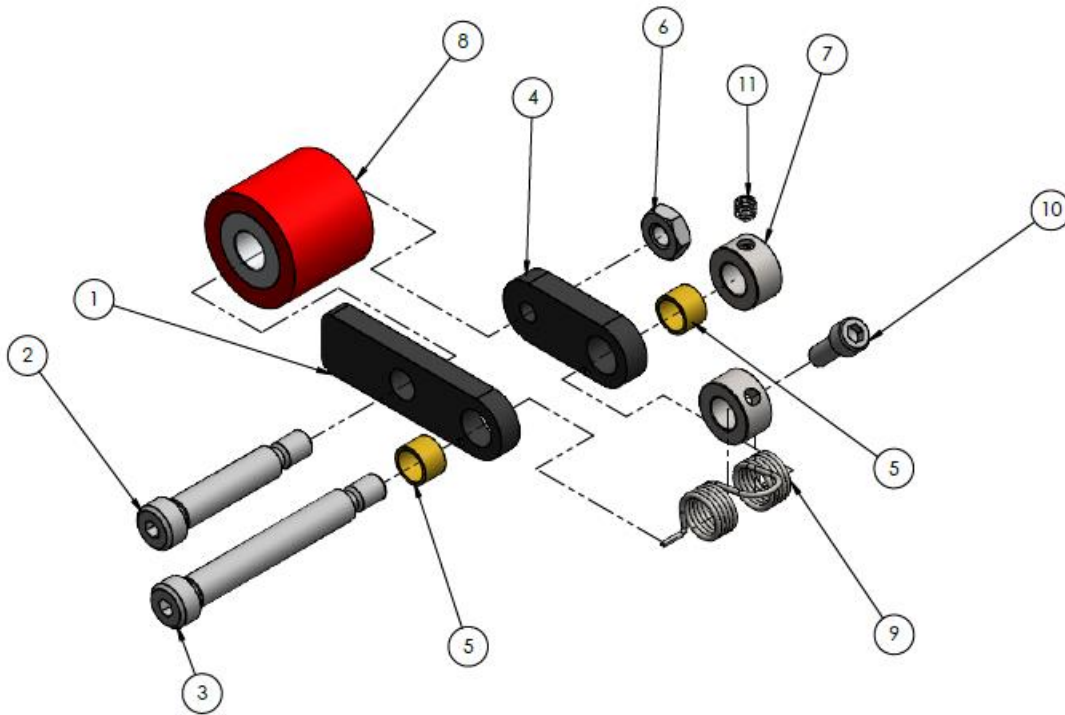

PN 111014 – Assembly Main Shaft

Item No.	Part No.	Description	Qty.
1	100014	MAIN SHAFT	1
2	5015	3/16 X 13/32 SQ KEY	1
3	600024	DRIVE GEAR	1
4	700015	GEAR HUB	1
5	700007	HUB	1
6	8210	CAM FOLLOWER	1
7	1177	10-32 X 5/8 FHCS BLK	2
8	1230	1/4-20 X 1/2 SOC SET KC	1
9	2030	1/4-28 X 1/4 SOC SET CUP	2
10	100560	TU ROLLER DRIVE PULLEY	1
11	100574	T/U ROLLER DRIVE BELT	1

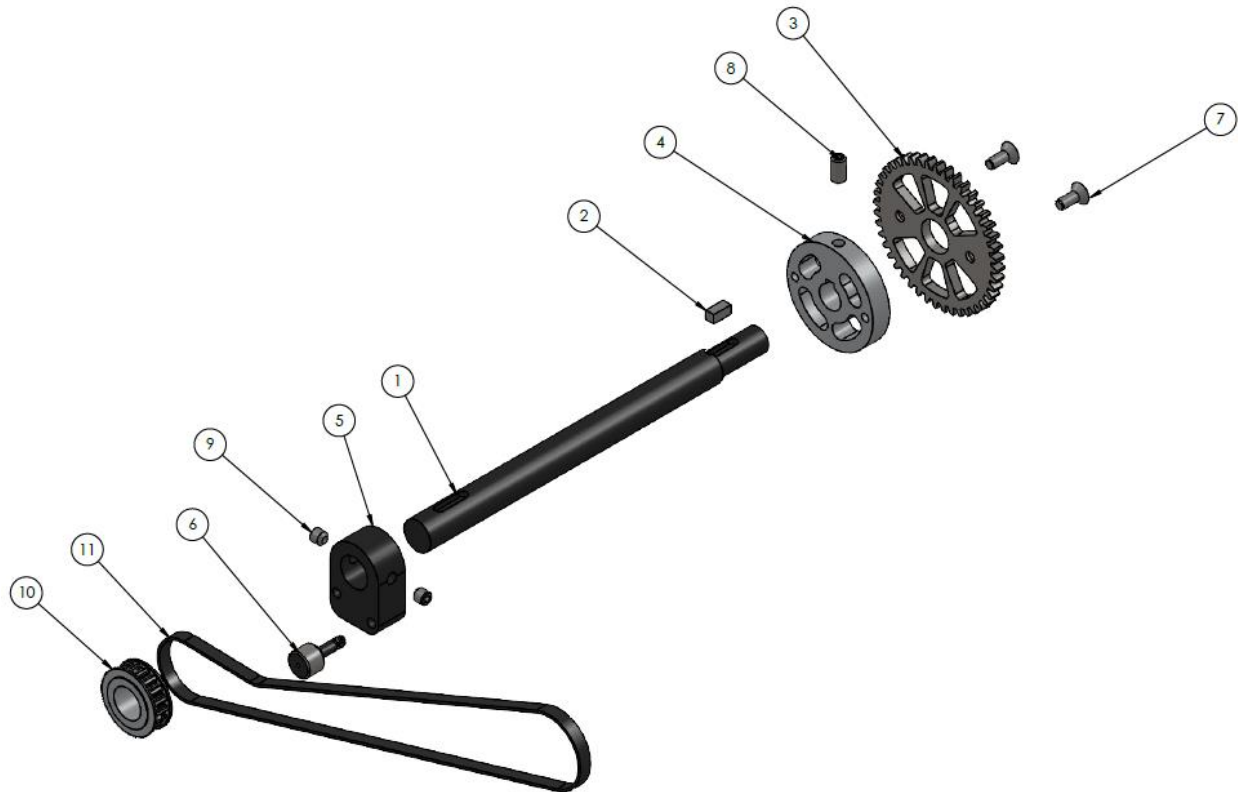

PN 111022 – Assembly Knife Pivot

Item No.	Part No.	Description	Qty.	Item No.	Part No.	Description	Qty.
1	100022	MOUNTING BAR	1	9	1050	5-40 X 3/8 SHCS BLK	2
2	700009	PIVOT FOR MOUNTING BAR	1	10	1241	1/4-20 X 1/2 LOW SHCS BLK	2
3	233021	DELIVERY BLADE/TUNGSTEN	1	11	4065	#6L FL BRASS WASHER	2
4	100018	STRIKER PLATE	1	12	1255	1/4-20 X 1/2 HHMS Z GRADE 5	1
5	700010	YOKE FOR PIVOT	1	13	100543	DELIVERY BLADE RETURN SPRING	1
6	3020	1/4 X 3/4 SH BOLT	1	14	8070	BUSHING	1
7	1190	10-24 X 1/2 SHCS BLK	2	15	700011	DELRIN INSERT	1
8	1185	10-24 X 3/8 SHCS BLK	2				

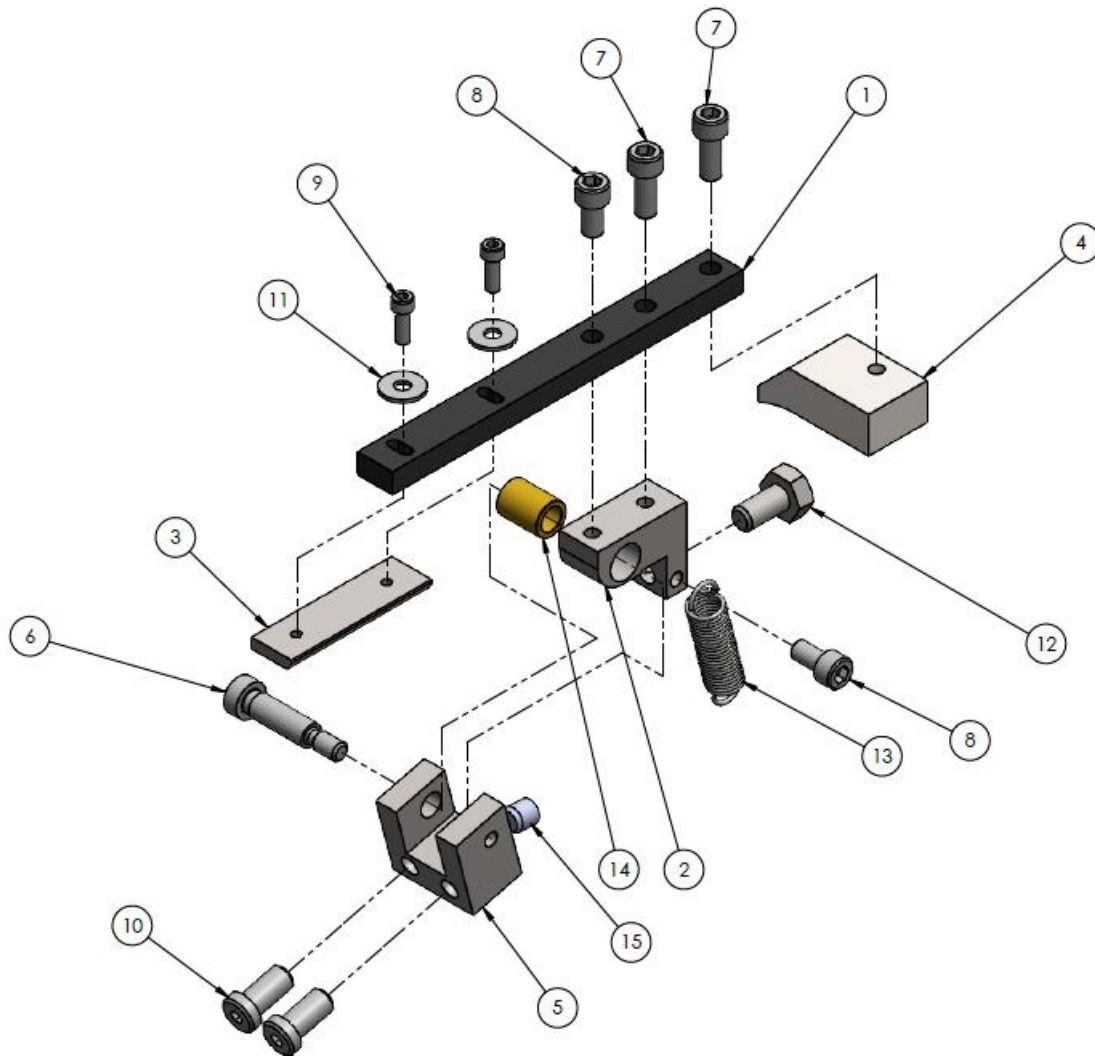

PN 111036 – Assembly Electrical Panel

Item No.	Part No.	Description	Qty.
1	200023	AMPLIFIER MOUNTING BLOCK	1
2	100507	FIB OPTIC AMPLIFIER/ONE TOUCH	1
3	100507-BRKT	100507-BRKT	1
4	100517	POWER ENTRY W/FUSE	1
5	100515	SWITCH ROCKER ON/OFF	1
6	1072	5-40 X 1/4 BHCS	5
7	100036	ELECTRICAL PANEL	1
8	1095	6-32 X 5/8 SHCS BLK	2

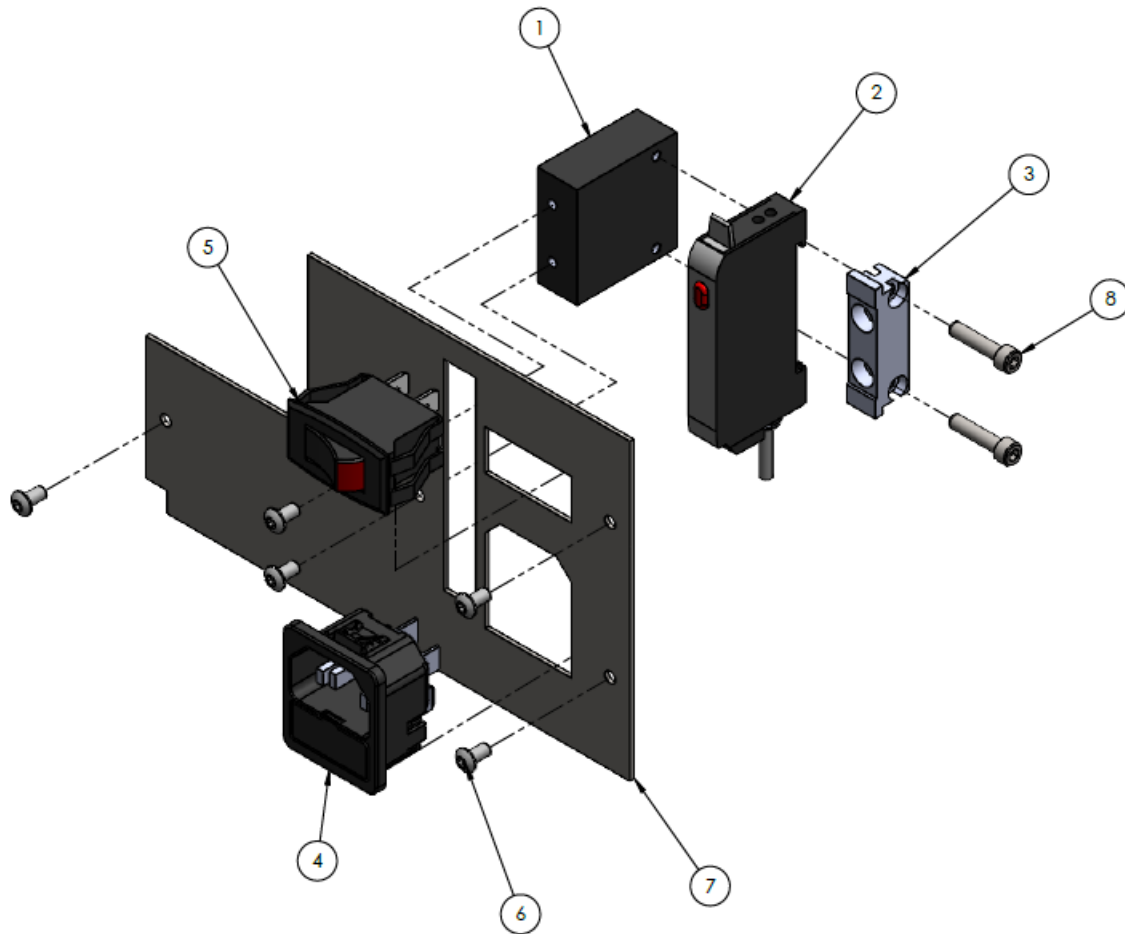

PN 111052 – Assembly Frame & Cover

Item No.	Part No.	Description	Qty.
1	100053	HEAD END PLATE	1
2	100002	BASE PLATE	1
3	100054	TAIL END PLATE	1
4	100035	MACHINE COVER	1
5	200024	PROX MOUNTING BLOCK	1
6	100509	PROX-INDUCTIVE DC	1
7	1242	1/4-20 X 3/4 LOW SHCS	2
8	1150	8-32 X 3/8 SHCS BLK	2
9	1061	5-40 X 1/2 SHCS BLK	2
10	1155	8-32 X 1/2 SHCS BLK	2
11	CLAMP	CABLE CLAMP	2

Item No.	Part No.	Description	Qty.
12	8195	BUSHING	1
13	8046	DOUBLE END 3/8" HOSE COUPLER	1
15	1072	5/40 X 1/4 BHCS BLK	7
16	7090	COVER HANDLE	1
17	1140	8-32 X 3/8 PHMS Z	2
18	1240	1/4-20 X 5/8 SHCS BLK	2
19	100080	PLATE PLUG MTG M6SA	1
20	1138	8-32 X 3/8 BHCS BLK	2
21	5561	CONNECT PLUG FEMALE 2 POS TABS	1

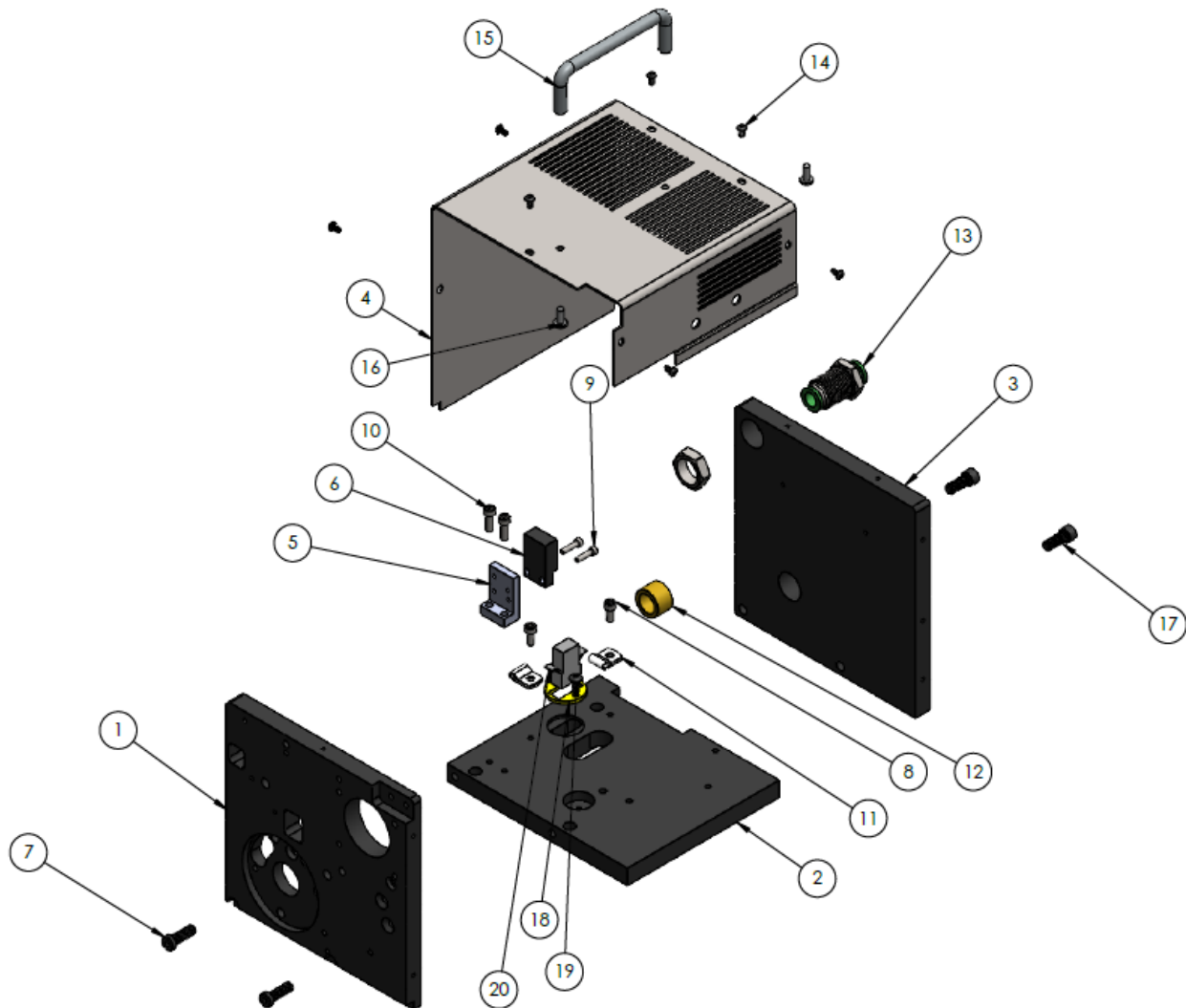

PN 111053 – Assembly Head End Plate

Item No.	Part No.	Description	Qty.
1	100053	HEAD END PLATE	1
2	200025	WEB IDLER ROLLER	1
3	100026	STATIONARY ROLLER	1
4	600027	STEM FOR STAMP RETAINER	1
5	500029	STAMP RETAINER SPRING	1
6	500028	CLAMP FOR STAMP RETAINER	1
7	1212	10-24 X 1 SHCS BLK	1
8	1040	5-40 X 1/4 SHCS BLK	2
9	4035	1/4-20 NUT Z	1
10	3050	3/8 X 1-3/4 SH BOLT	1
11	8205	ROLLER BEARING R-6 DBL SEAL	2
12	5069	3/8" GRIP RING	1
13	5028	1/8 X 1/2 SPR PIN Z	1

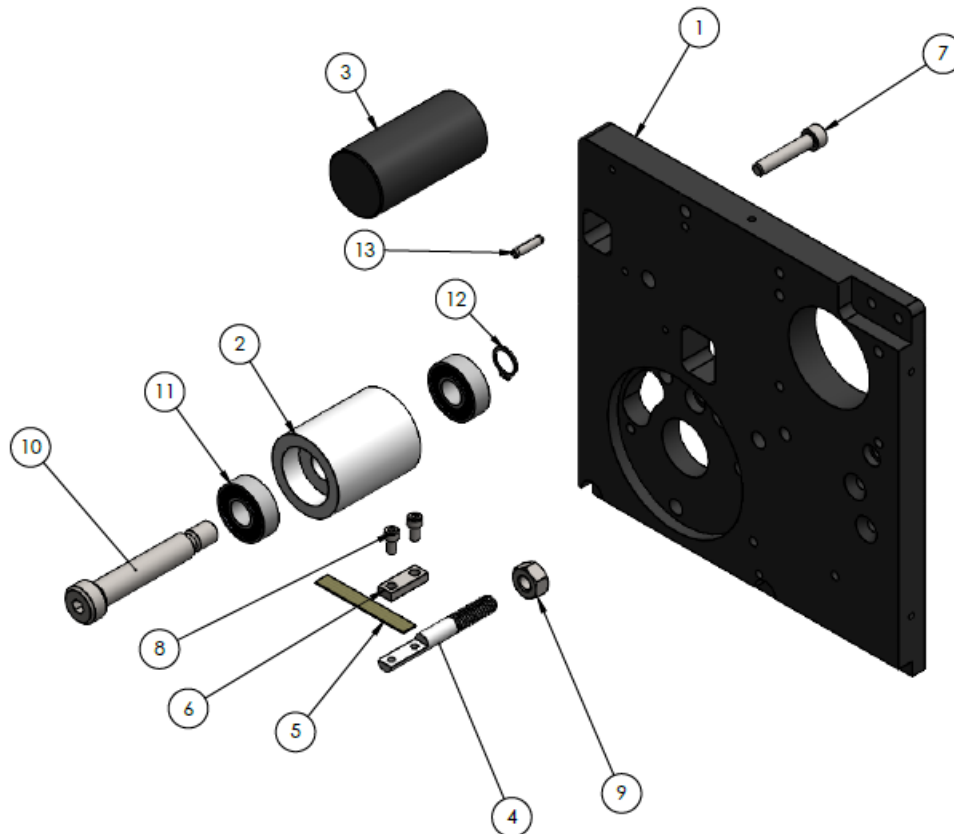

PN 111055 – Assembly Back End Panel

Item No.	Part No.	Description	Qty.
1	100053	HEAD END PLATE	1
2	111056	DC DRIVE MOTOR ASSY	1
3	500045	ANCHOR	1
4	8095	BUSHING	1
5	1215	10-24 X 1/2 HHMS Z	1
6	4055	#8 FL WASHER Z	1
7	1195	10-24 X 5/8 SHCS BLK	3
8	3045	3/8 X 3/4 SH BOLT	1
9	8205	ROLLER BEARING R-6 DBL SEAL	2
10	5069	3/8" GRIP RING	1

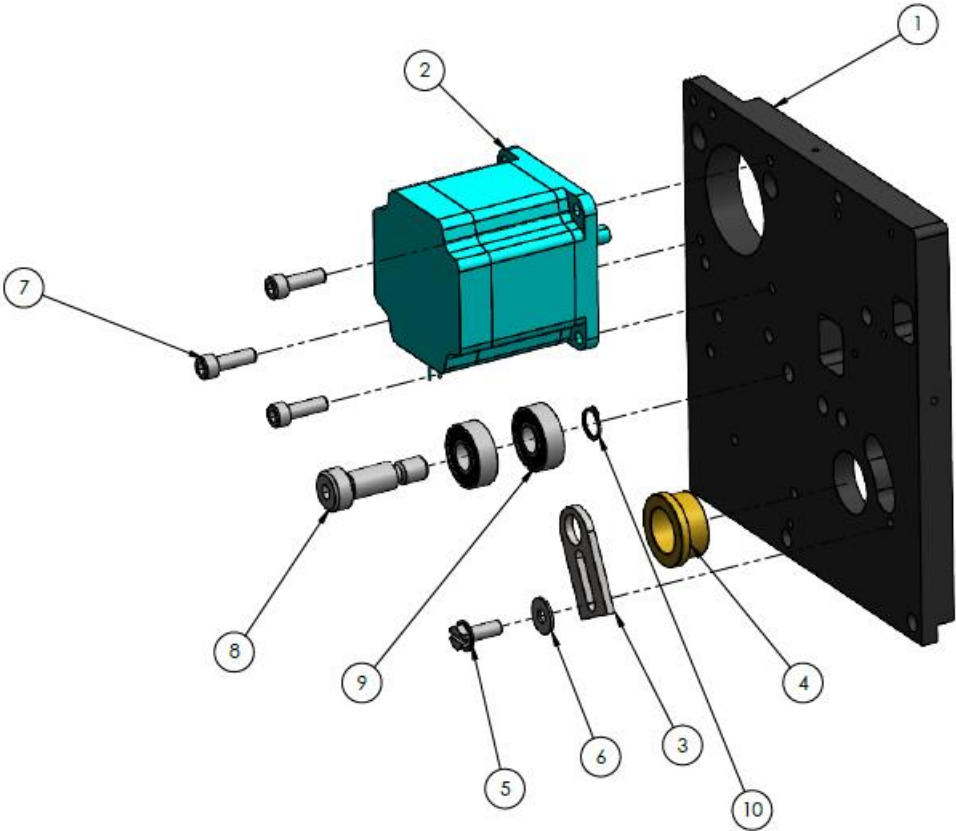

PN 111058 – Assembly Traction Feed Roller

Item No.	Part No.	Description	Qty.
1	100059	MOTOR SHAFT EXTENSION	1
2	200020	TRACTION FEED ROLLER	1
3	100055	OUTBOARD BEARING PLATE	1
4	8185	BUSHING	1
5	100057	BEARING PLATE SHAFT	2
6	1120	8-32 X 1/2 FHCS BLK	1
7	1130	8-32 X 3/4 FHCS BLK	2
8	2010	10-24 X 1/4 SOC SET G	2
9	1224	10-24 X 1/4 SOC SET CUP PT BLK	2
10	1121	8-32 X 1/2 FHCS SS	1
11	100513	SWITCH REED INTERLOCK	1
12	1115	8-32 X 3/8 FHCS BLK	1

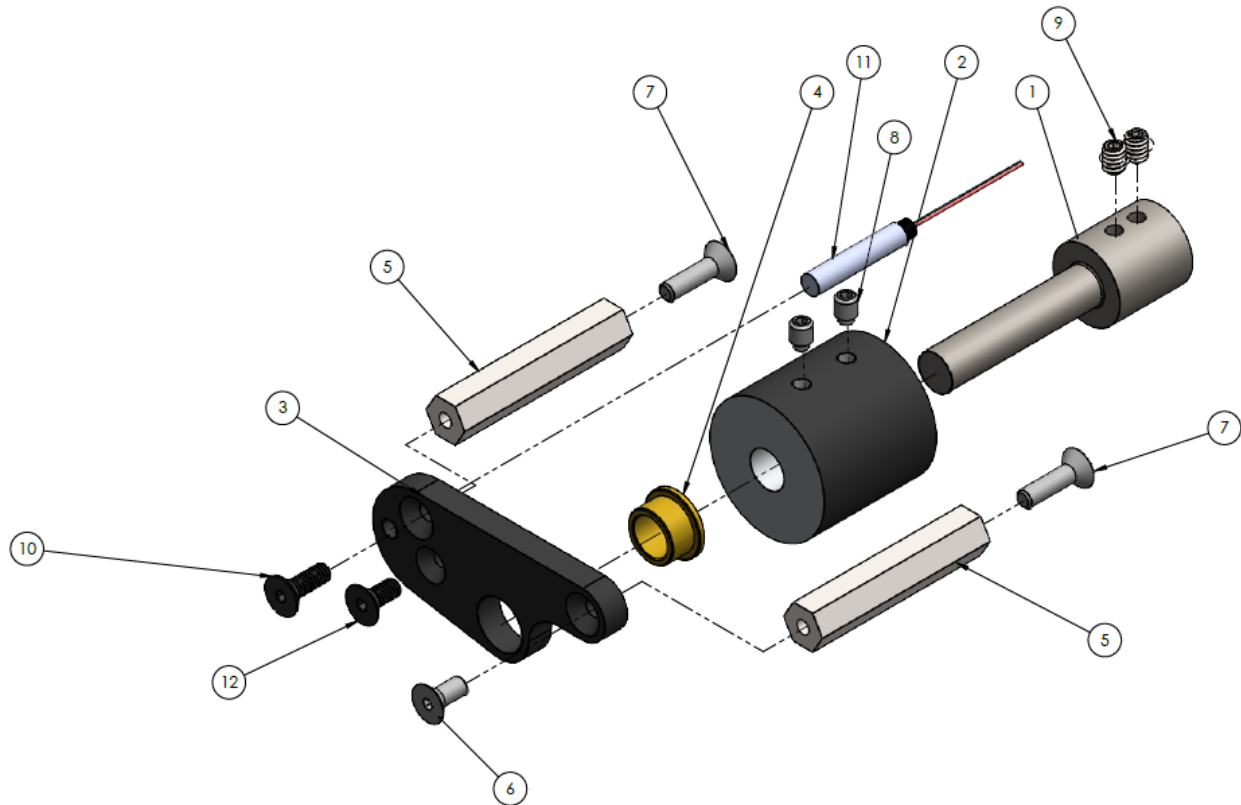

PN 111070 – Sub-Assembly Circuit Board Pwr Supply

Item No.	Part No.	Description	Qty.
1	1082	6-32 X 1/4 PHIL PAN M/S ZP	8
2	100506	POWER SUPPLY AC/DC	1
3	100070	PLATE MOUNTING ASSY	1
4	111510	CIRCUIT BOARD ASSY	1

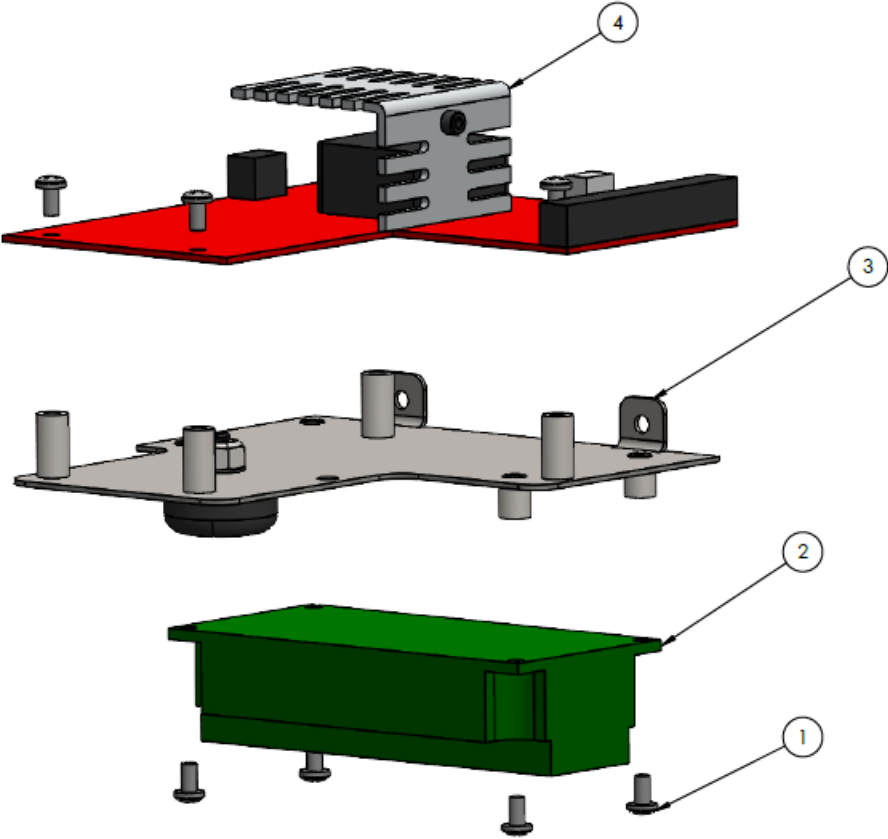

PN 111071 – Assembly Circuit Board Pwr Supply

Item No.	Part No.	Description	Qty.
1	100064	PLATE STAND OFF	1
2	1220	10-24 X 3/8 BHCS BLK	1
3	1195	10-24 X 5/8 SHCS BLK	1
4	111070	CIRCUIT BOARD ASSY	1
5	1040	5-40 X 1/4 SHCS BLK	2

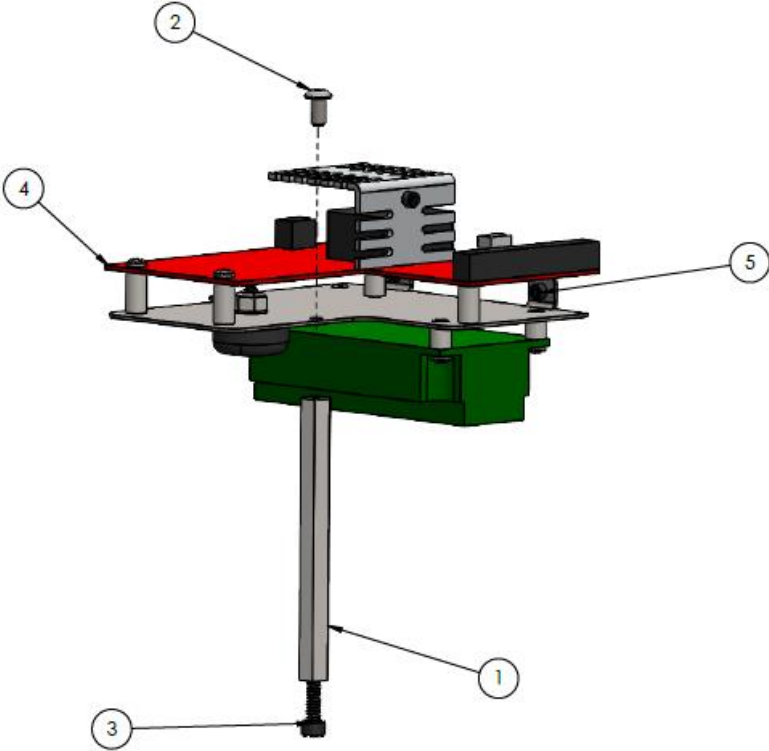

PN 111078 – Assembly Interlock Cover

Item No.	Part No.	Description	Qty.
1	100078	COVER INTERLOCK LEXAN	1
2	100076	HINGE COVER INTERLOCK	1
3	100074	STAND-OFF HINGE INTERLOCK M6	2
4	100084	MAGNET INTERLOCK COVER	1
5	100086	KNOB INTERLOCK COVER	1
6	100055	OUTBOARD BEARING PLATE	1
7	1137	8-32 X 1/4 BHCS BLK	2
8	40211	NUT 8-32 NYLOC LOW PROFILE	3
9	1138	8-32 X 3/8 BHCS BLK	3
10	1120	8-32 X 1/2 FHCS BLK	1
11	1130	8-32 X 3/4 FHCS BLK	2
12	8185	BUSHING	1
13	1115	8-32 X 3/8 FHCS BLK	1
14	1121	8-32 1/2 FHCS SS	1

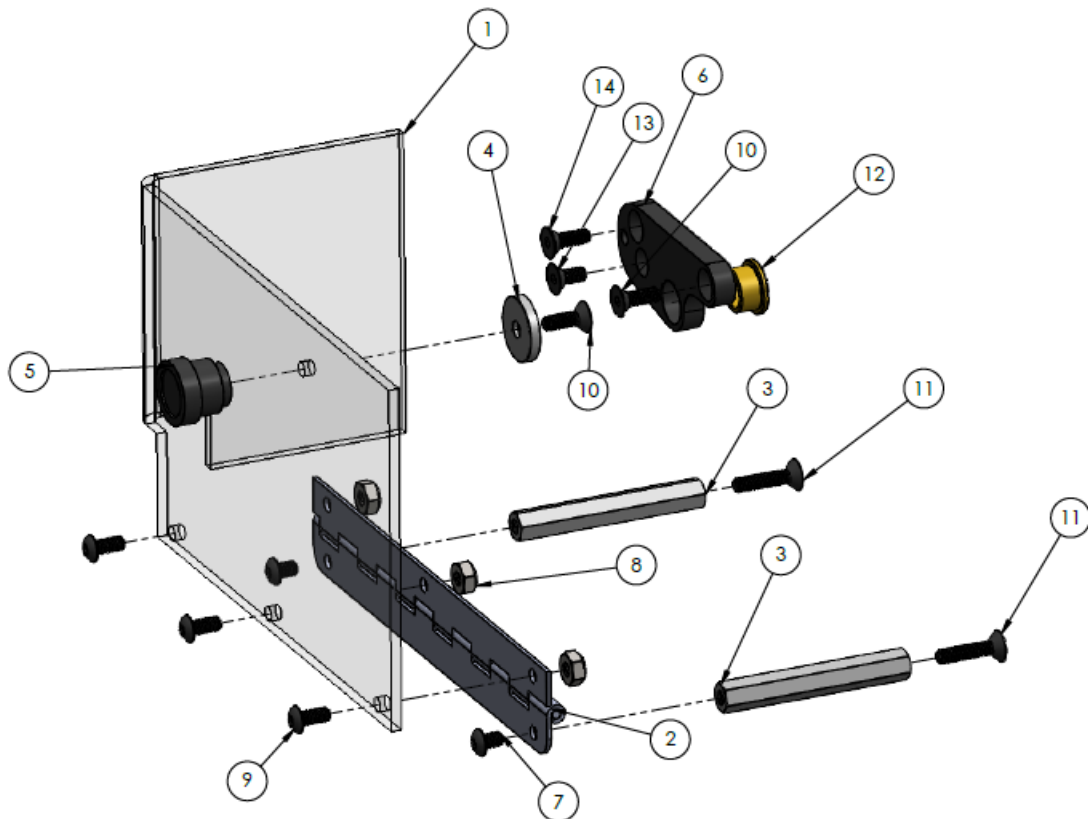

Technical Support

Postmatic is known for their excellent level of customer service and support within the industry. We provide both remote and onsite support for all Postmatic and Non-Postmatic equipment nationwide.

- Please reference our [YouTube Channel](#) for Instructional Videos
 - https://www.youtube.com/channel/UCJ4IQGc7Xq-K_9n6GhOOmxA/playlists
- View [Equipment Parts Manuals](#)
 - <https://postmatic.net/equipment-parts-manuals/>

If you are an end user and need technical support, please contact your dealer!

All dealers and those who don't have a dealer may contact Postmatic for technical support.

Thank you,

Postmatic

Website: www.postmatic.net

Email: info@postmatic.net

Phone: 763-784-6046

Address: 9405 Holly Street NW – Ste D | Minneapolis, MN 55433